

axares | Decorative Street Lights

axares 2204

- classic lantern-shaped lamp
- Luminaire glass PMMA clear or satined
- Optics PMMA lenses in multilayer technology
- Housing made of powder-coated aluminum
- Post-top with spigot size 60/76 mm
- Dimensions: H = 603 | ø = 400 (mm)
- Total weight 7.8 kg
- Degree of protection: IP65, protection class I
- Power reduction switching phase, ChronoStep, Dali
- Housing color DB703, others on request
- Dielectric strength 10kV

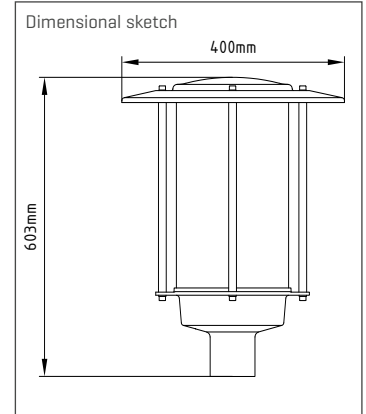

Designation	Lens [●]	Light Color [◆◆]	System performance [W]	System performance typ. [■■W]	LED assembly	System luminous flux [lm]
2204■●00◆◆ME-●AY	S/X/C/B	27/30/40	7 - 19	7/13/19	1 x 2x4	846 - 2362
2204■●00◆◆ME-●AY	S/X/C/B	27/30/40	18 - 32	18/22/32	2 x 2x4	2208 - 4175
2204■●00◆◆ME-●16	Y/V/M/S/B	AM/27/30/40	7 - 19	7/13/19	1 x 4x8	1144 - 3017
2204■●00◆◆ME-●16	Y/V/M/S/B	AM/27/30/40	18 - 32	18/22/32	2 x 4x8	2985 - 5023

- » [LVK: Residential streets, parking lots \[Lenses: A, B, C, D, F, S, V, X\]](#)
- » [LVK: Cable span lights \[Lenses: N, O, U\], Major roads \[Lenses: M, E, Y\], Pedestrian crossings \[Lens: R\]](#)
- » [LVK: Planar radiator / Industrial Lights \[Lenses: F, I, P, 1550, T, SY10, SY20, SY60, SY120\]](#)

Article number assignments | Explanation

Example: 1202■●00◆◆ME-●16

- 1202 Model number
- System performance typ. e.g. 07 / 13 / 19
- ◆◆ Light color 27=2700K, 30=3000K, 40=4000K, AM=Amber
- BA / ME BA=Basic / ME=Medium
- Lens
- AY HighPower LED
- 16 MidPower LED

E.g. 1202190030ME-S16

Model 1202, 19 Watt, 3000K, Medium, MidPower LED with S-Lens

TRS-STAR GmbH

Werner-von-Siemens-Str. 1
76297 Stutensee

Planning and technical sales
Dipl. Ing. Frank Werz
T +49 6233 347-125
werz@trs-star.com